

Opel GT Electrical System Notes

Feedback from Opel GT owners indicates that the electrical systems of these classic vehicles now require maintenance!

The most frequent reports indicate irregular operation of some lighting circuits and fluctuating gauge readings, which aren't surprising, as original copper and brass components of these cars have been in place for at least 40 years.

More specific concerns arise on long-neglected "barn find" GT's, as well as GT's being completely stripped down for interior restoration, or newly-repainted GT's. Opel GT owners commonly reference a generic wiring schematic, take a glance at the GT fusebox, then collectively scratch their heads wondering 'what hath Opel wrought'?

As challenging as the GT electrical system appears at its first impression, the good news is almost all these circumstances share solutions in common: A need to verify correct location and function of individual circuits, and a need to identify and clean connections & grounds.

The first step of any Opel GT owner should be to acquire a collection of individual circuit schematics. These were originally printed in the 1971, 1972 and 1973 Opel Factory Service Manuals - but if you don't have the actual manuals copies of the schematics are also available in various places. These are a vast improvement over the "all in one page" type schematics (found in all other Opel guides, including the 1969-70 factory manuals, Chilton's, Clymer's and Brooklands).

Index Guides

The following "Index Guides" is intended to provide a "link" between the individual circuit guides, and how these circuits are actually mounted and connected on the car.

It's important to also be aware that not all GT's were wired identically (there were minor changes made for equipment options and between some model years).

US-export GT A/L's also vary from European-market models (which added passing lights and other functions, while deleting side markers and some dash options), but as these are so rare they are not detailed here.

It's also important to note that individual GT's are likely to also have had modifications performed by prior owners (particularly involving additions of stereos and alarms, and bypasses within the headlight and starting circuits).

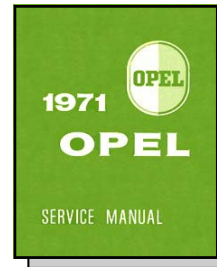

Recommended:
Circuit Wiring
Schematics
*(found in original
1971-1972-1973
Opel factory manuals)*

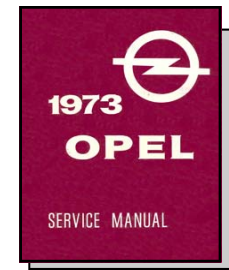

Variations

Opel GT Wiring Harnesses included additional circuitry when optioned with:

- Automatic Transmission
- Rear Window Defroster
- Air Conditioning
- 1100cc engine (model "93")
- European delivery (passing lights, etc)

Year-to-Year Wiring Changes

1968-69 GT's: Headlight Microswitches and Turn Signal Stalk Wire variation

1972-1973: Seat Belt "Buzzer" and Parking Brake Lever indicator added

1973: Taillights varied from earlier models

"European Standards"
are integrated within
the wiring design
of classic Opels.



A critical example is use of color codes. On Opels:

BROWN = GROUND

BLACK = SWITCHED POWER (12Volts DC/Ignition On)

RED = BATTERY POWER

Other quirks include parking lights which can be activated by the turn signal stalk (even when the power is off!) These differences from most American cars should be understood & explained upfront to your mechanic!

GT Electrical System Inspection

When evaluating a long-stored (or a “barn find”) Opel, certain checks should be performed to ensure the electrical system is in a condition for safe operation. This can also apply to any GT which it is acquired by any new owner, or to evaluate wiring prior to a “full restoration” (when the interior is to be stripped).

Visual Inspection:

Check for power wires left disconnected, or for harnesses cut or chewed by mice.

Turn Engine Manually:

Turn a 19mm wrench on crankshaft pulley bolt clockwise to ensure engine rotates (before turning the key the first time to engage the starter).

Check Headlights:

Verify headlight buckets can be rotated easily (and won't scrape paint on body).
Verify headlight wires don't have cracked insulation (always replace original wires!)
The GT headlight circuit is rather complex and requires consultation for diagnosis; A diagnostic guide is online at OMC's website at: <http://www.opelclub.com>

Battery Hookup: When first connecting battery, listen/look for evidence of a shorted circuit (if you hear crackling or see a puff of smoke, disconnect immediately).

Service Power Points:

Clean and check Battery Positive Terminals, Alternator B+ output, Amp Gauge, Fusebox Center Terminals
Also clean sockets for Light Bulbs (replace with 21W bulbs for better turn signal & brake light operations)

Clean Chassis Grounds:

Clean connections to Battery Ground Terminal, Engine Ground Cable, Alternator Ground Cable, bulb connectors, etc.
(See diagrams on next page for additional information)

Other Cautionary Evaluations:

Underhood Area:

- Replace existing battery cables, as corrosion can “hide” within casings and prevent starting.
- Check fan belt tightness and condition; Replace if cracked, dry-rotted, glazed or very worn
- Verify presence & integrity of upper & lower alternator mount bushings.
- Verify wiring connections and harness condition at the rear of the Alternator
- Check condition of window wiper blades (before activating the switch).
- Starter Solenoid: Inspect plastic housing for cracks (particularly if Delco type)
- Fusible Links: Don't bypass these in power circuits, as they are critical safety components

Dash Panel:

- Ignition Switch: Measure impedance at White Plug (at end of loom from Steering Column).
- Install relay in starting circuit for longer-term protection of ignition switch.
- Steering Column: Turn key to operate ignition switch, and to test accessory circuit functions
- Hazard Switch : Push button carefully, as internal spring snaps easily
- Parking Switch: Middle button has no function, and will break if pressed hard

Function Tests:

Dash Gauges:

Once engine is running, monitor readings on oil, temp & tank gauges

Charging Circuit:

Monitor Amp gauge readings, and take voltage reading at battery when running if questionable

Exterior Lights:

Check operation of parking lights, turn signals, brake lights, headlights, hi-beams & horns

Tune Ups

See June 2006 OMC Blitz article on additional Opel Engine tuning procedures

Additional details on Opel GT Wiring appear on the following pages

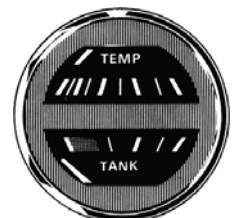
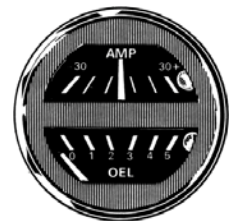
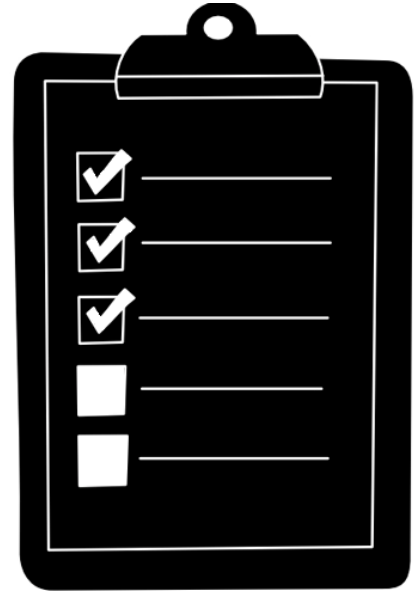

GT Electrical System Components

The Opel GT originally featured full instrumentation (a rarity on any mid-1960's production model!). This required development of a complex dash gauge panel and wiring harness, compacted to fit a tight area.

As its 40+ year old plastic housing is now brittle and cracks easily, owners need to consult written instructions prior to removal of the original panel for service.

Opel GT Source offers new bulbs as replacements for burned-out or missing original bulbs. Bulb number counts (as well as gauge styles and switch functions) varied between model years, so inspect your panel for accuracy if an original restoration is planned. Additional notes can be found in the Opel GT Source print-version "part list".

Replacement Dash Gauge Panel Bulbs

- 5030 Clock Bulb
(This bulb style was also used in auto trans consoles)
- 5036 Gauge Bulb
(From 6 to 8 of these bulbs are in GT gauge panels)
- 5036 Peanut Bulb
(From 6 to 8 of these bulbs are in GT gauge panels)

Opel GT Source also offers the #5076 bulb for the dome light, as well as additional bulbs for the exterior light assemblies (which are described elsewhere, including in our print-format "part list")

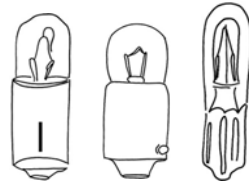
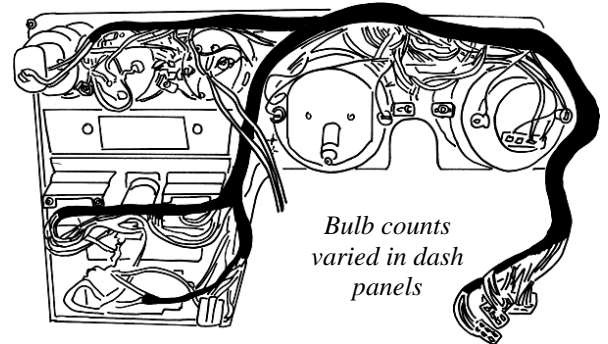
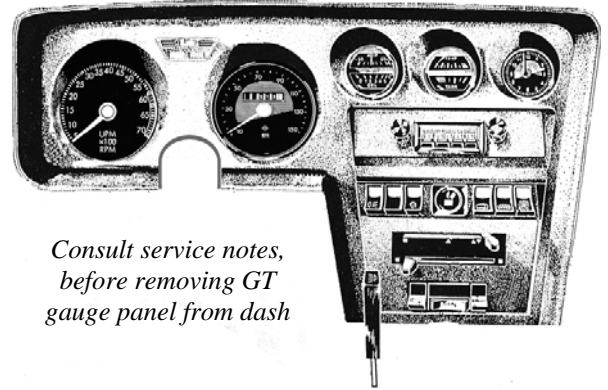

5030 5036 5037
Dash Bulb Styles

Dome
Light
Bulb

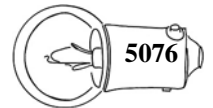

(Note: Bulbs are shown larger than actual size, for clarity)

Opel GT Fuses & Fusebox

Fusebox Notes

The fusebox serves as the "nexus" of the Opel GT electrical system. Now, most original housings are old, brittle, and cracking or falling apart. One solution available for a complete restoration, is a new replacement housing.

- 5024P Plastic Fusebox Housing
- 5024S Metal Fusebox Housing

Another option is adding an external "gusset" frame for support,, per the instructions illustrated on a following page.

Opel GT Source also offers hard-to-find German fuses

- 5029 Fuses, Set
(Includes set of 7 fuses, plus a few extras)

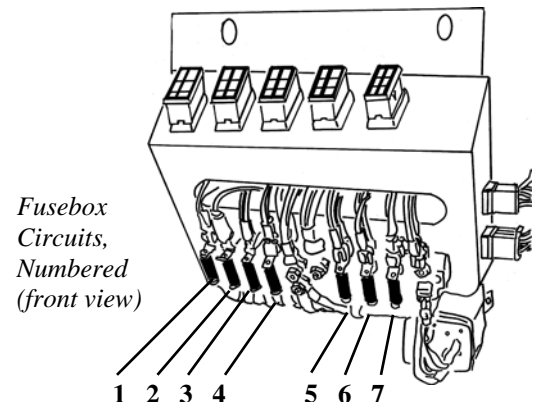

Opel GT Turn Signal/Hazard Circuit

The stalk on the Opel GT steering column was designed for a dual function: Depending on the direction it is operated, it controls either the turn signals or selection of the high/low beam headlights.

There was a design difference in this stalk which originally varied by model-year:

Early 1968-1969 style had an end “button” for high beams, while later 1970-1973 GT’s used a hinged internal turn-signal ring (that was pulled towards the driver for high-beam headlights).

Note: When the ignition key is off, if this lever is switched to either direction, it actuates that direction side parking lights!

The frequent motion involved in operating this stalk, results in metal fatigue at the internal turn signal ring, which is prone to breaking over time.

Turn Signal Ring

5064 Turn Signal Ring, 1970-1973 GT
(Includes hinged contact switch for high/low beam selection).

Turn Signal Dash Panel Indicator Lights

When a turn signal is operating, an indicator bulb on the dash panel will flash.

Required maintenance of the turn signal circuit includes cleaning bulb contacts and ground wires at each of the 4 exterior light housings, and changing bulbs (using new original 21-watt European bulbs for correct circuit function). Verification that the hazard light switch is functional, is also required.

Turn Signal Circuit Bulbs

5037 Dash Indicator “Peanut” Bulb (1970-1973 GT)
5256 Turn Signal Bulb, Exterior Front (1968-1970 GT)
5256 Turn Signal Bulb, Exterior Rear (1968-1973 GT)
5257 Turn Signal Bulb, Exterior Front (1971-1973 GT)

A commonly-seen “double yellow” scenario on GT’s is that both indicator bulbs will flash simultaneously, which indicates a burned out bulb, incorrect bulb current, or a fault in that circuit. If this condition is not resolved with maintenance and a set of new bulbs, a new replacement relay is also available to restore proper circuit function.

Turn Signal Relay (Replacement)

5014 Modern Turn Signal Relay Conversion Kit
(This is a new modern relay, that cures the “double yellow” dash indicator flashing. Requires one wiring modification—Detailed installation instructions are provided).

Steering Column Disassembly & Tool Kit

Replacement of internal items (such as the turn signal ring) requires service to the Opel GT steering column. To avoid damaging this hard-to-replace component, we strongly advocate that owners consult steering column disassembly notes prior to performing any service work.

We also offer a steering column hub puller kit (which includes a pair of the correct required oval-shaped bits)

12110 Steering Wheel Hub Puller Kit
(Includes disassembly notes; Offered as a “convenience item” to save you a trip to the store)

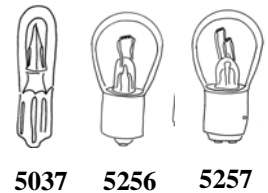
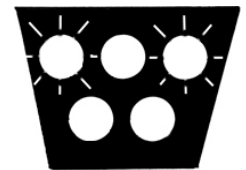
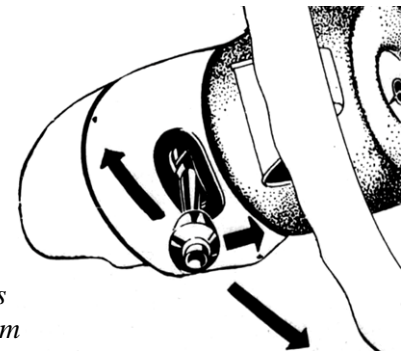

Bulb images: Not to scale

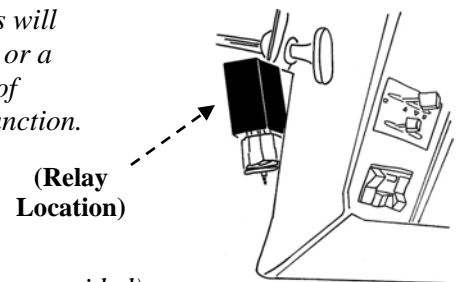

(Relay Location)

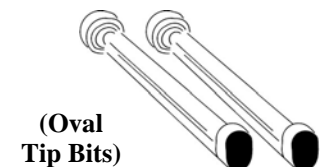
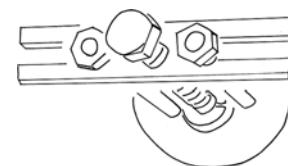

(Oval Tip Bits)

Opel GT Ignition Switch

Located within the steering column, this important switch was wired within a circuit that ran a full 30 amps of power ran through it, every time the starter was cranked to start. This caused carbon deposits to accumulate internally within the switch, which over time caused many to burn out.

Opel GT Source has reproduced this critical item, to help ensure that your GT will be able to start when you need it . We also strongly recommend consulting our installation instructions (available with purchase) prior to disassembly of your steering column.

5060N Opel GT Ignition Switch

To help prolong the life of a new (or existing) ignition switch, we also recommend adding a 30-amp relay within the ignition/starter circuit.

(We suggest using the Radio Shack #275-226 relay or equivalent, as it is readily available and typically priced for less than ten dollars. Circuit rewiring instructions are available; They are most commonly supplied with our print-version "part list").

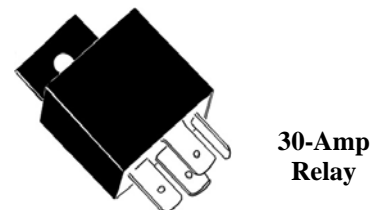

Opel GT Starter

Classic Opels are designed to start with a "Vroom" with just a tap of the ignition key.

To help share this feeling, Opel GT Source offers an All-NEW Permanent Magnet Starter.

This is a lightweight, High-Torque design that provides faster engine cranking than worn-out original Opel starters, which also really helps restore "hot re-starting" capability (sometimes affected by modern ethanol-blend fuels).

Easier to Install, and fits 1.9L (& 2.0-2.2-2.4 CIH) Opel Engines.

5027PM Starter, Permanent-Magnet style. NEW

(No exchange or core fee is required on this item).

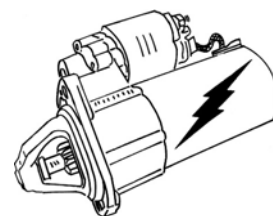

Opel GT Battery and Charging System

The condition of your wire harnesses, power cable and ground connections, greatly affects your charging system.

Battery & Related

5019 Battery Box, Steel, Opel GT

Can be installed with bolts or welds to frame

5025 Battery Cable, Positive, Opel GT

5026 Battery Cable, Ground, Opel GT

5078 Engine to Chassis Ground Strap

Charging System

5017 Wiring Harness, Alternator to Regulator

All new 13" length harness, includes new plug ends for more secure connection and connected D+ wire end (for connection to amp meter light)

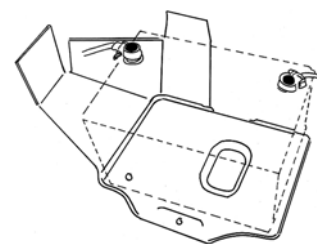
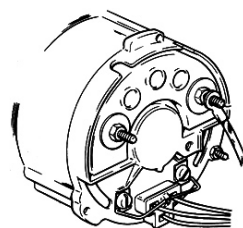

#5019 Battery Tray and #5025, #5026 Cable Connections



#5078 (Engine to Chassis) Ground Strap

Important Note:

To avoid damaging hard-to-replace Opel GT electrical system components, we advise prior to starting any service to consult Opel GT electrical system notes, such as our tech notes regarding Headlights, Exterior Lights and Ignition System parts, which are available elsewhere on our website (or are available with orders of related parts).

GT Wiring Harness Notes

Opel's "Harness Based" Approach

Here at Opel GT Source, we get inquiries for GT wiring harnesses.

Rather than perform the troublesome (and sometimes expensive) procedure of replacing the entire GT wiring system, we instead advise owners to inspect all individual electrical system functions and then replace specific wires, looms or pieces that are inoperative.

Repairs can also be made more simply by referring to the GT's original "harness-grouped" wiring loom schemes on following pages. Functions can be traced here and associated to a particular harness, then bypassed or replaced individually.

Unless absolutely necessary, it may be better to only repair individual wiring functions or replace circuits as needed (rather than to re-wire an entire body). For example, it's much easier to externally support a cracked original fusebox than to re-wire it! A generalized view of one splicing approach is below.

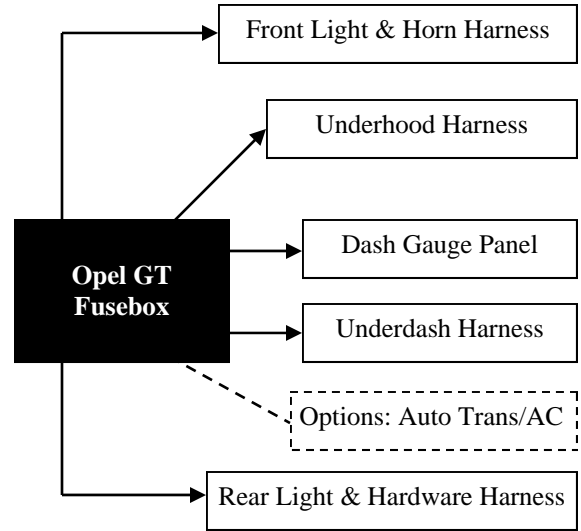

Basic Structure of Opel GT Electrical system
Illustrates harness-grouped applications, which are powered from the fusebox.

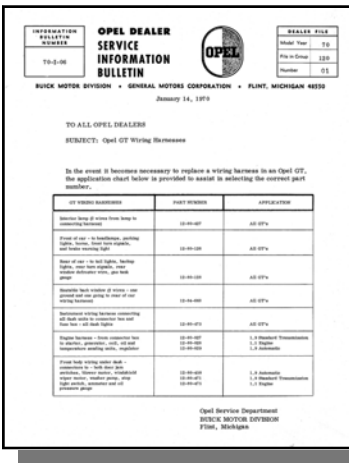

Important Wiring Harness Notes:

Designs of Wiring Harnesses installed on USA Opel GT's changed throughout the original 1968-1973 production schedules, per Opel's own part bulletins.

Color variations include a grey harness sheath used through December 1971; Later 1972-1973 harnesses had black wrapping

(We caution GT owners that replacement harnesses offered for sale for European GT's are not only expensive but include circuits that are not meant for US-export GT's. We also caution owners regarding "all-in-one" replacement wiring kits, which were originally developed for use on American muscle cars, as some who have installed them have reported problems trying to operate critical European-designed headlight/parking light and turn signal/hazard light circuits and switching functions on the Opel GT).

Harness Splicing Notes

- (1) Always disconnect battery before servicing electrical system.
- (2) Work only in a well-ventilated area, where gas fumes are not present.
- (3) Handle wire ends carefully, to protect original slide connectors.
- (4) Refer to diagram at right as a conceptual guide if adding new wire.
- (5) Apply a flux compound when soldering for optimal connections.
- (6) Insulate all connections with heat-shrink sleeves or quality tape.

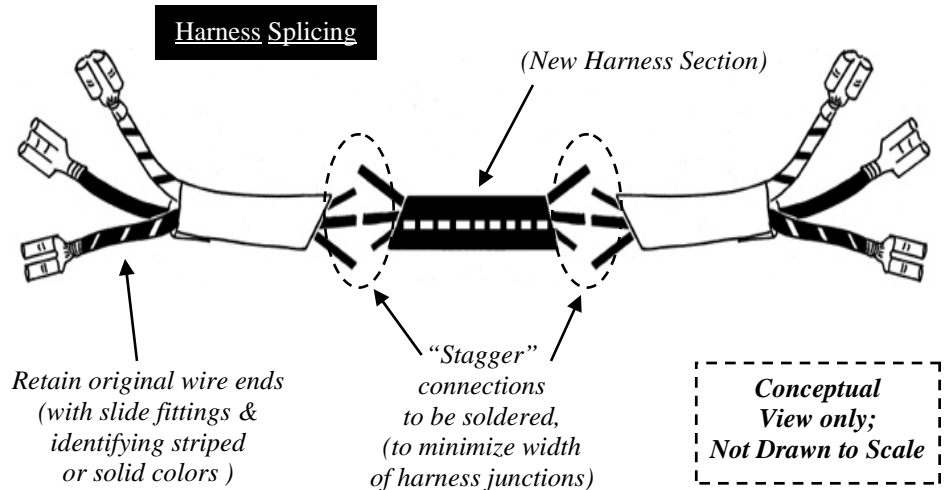

GT Ground Contact Maintenance

Many operating difficulties arise from corroded or missing ground connections. Required maintenance now includes using sandpaper to restore a proper electrical ground to the chassis. This is even more important, just after a GT has been re-painted! Some of the more critical chassis locations are illustrated here.

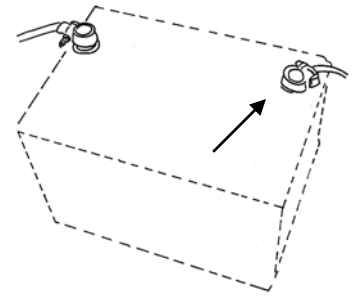

Battery: Replace ground cable, and clean contact at bolt to frame

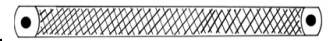

Engine Ground Strap: Connects chassis to lower passenger side of engine

Distributor: Clean condenser mount (on side of housing)

Heater Fan

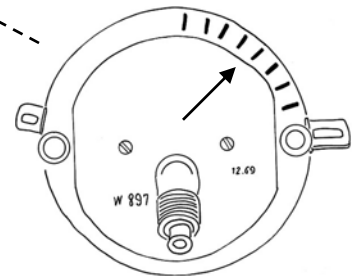

Speedometer (Rear): Many dash components are grounded in common here

Taillights

Ground wire eyelets are connected by screws located within body recess. These greatly affect operation of turn signal circuit, particularly when paint interferes with connections.

Headlights

Ground wire eyelets are connected by screws to chassis at inner fender

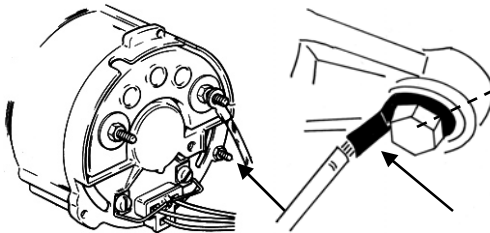
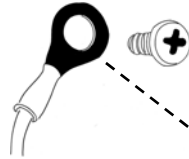

Alternator Casing

Connects from edge of alternator to 15mm bolt-head on lower alternator support bracket to engine

Fusebox & Dash Area

Numerous important grounds are located adjacent to these areas. Look for brown wires, and clean all accessible connections.

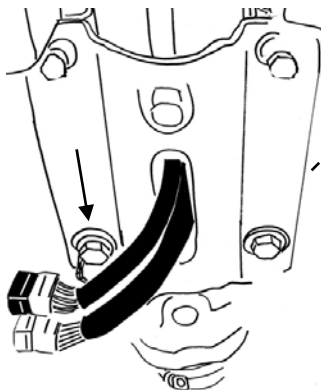

Steering Column

Important ground connects to lower 13mm bolt on support bracket (affects high beam switch). Additional grounds within column affect turn signal switch & horn.

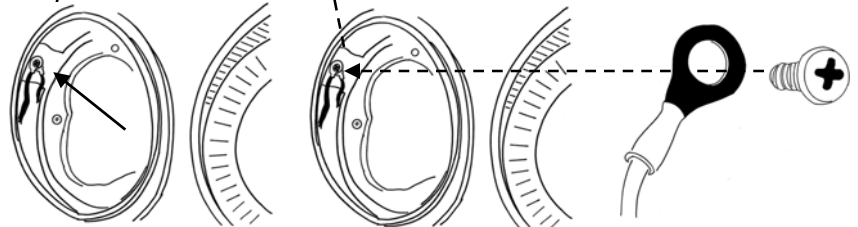

Fusebox "Terminal Reference Guide"

Disclaimers:

The following diagrams are based on a teardown of a 1971 GT. These diagrams are for reference only—the actual wiring on your car may vary, based on its model year, installed options, and whatever a mechanic or prior owner may have altered. Wire terminals may vary vertically within any particular circuit, and circuits for the rear window defogger and 1972-1973 seat belt buzzer aren't shown. We advocate confirming all wire applications using a continuity tester. OMC does not accept responsibility for your actual results.

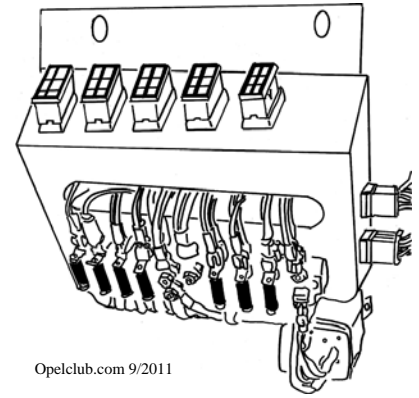

Opelclub.com 9/2011

"Front View" Fusebox Terminals*

#1	#2	#3	#4	#C/L	#C/R	#5	#6	#7	#R/S
			Red	Red	Red	Gray/Black	Gray/Red	Gray/Green	Black/Green
Black	Black	Trans-parent	Red	Red	Red	Gray/Black	Gray/Red	Gray/Green	Black/Green
						Gray/Black	Gray/Red		Black/Green

Applications per Terminal

- #1: Ignition Switch, "On" Power setting
- #2: Headlight Relay Microswitch (Main)
- #3: Ignition Coil, Positive Terminal
- #4: Ignition Switch, "Battery Power" setting
Parking Light Switch
- C/L: Amp Gauge "L+" Power Input

*Always check front/rear and top/bottom orientation, by noting fuse terminal locations

Applications per Terminal

- C/R: Alternator "B+" Power Input
Power to Headlight Main Relay
- #5: Parking Light Switch, Turn Signal Switch,
Headlight Main Relay (Running Light Circuit)
- #6: Parking Light Switch, Turn Signal Switch,
Headlight Main Relay (Parking Light Circuit)
- #7: Parking Light Switch, Headlight Main Relay
- R/S: Right Side Turn Signal Circuit

Important Fusebox Maintenance Notes

Factory Wiring Schematics are Reversed!

While the best wiring guides are the individual circuit diagrams (available in the 1971, 1972 and 1973 Opel Factory Service manuals), **You must be aware that the fusebox terminals are shown in a order that is the reverse of the view you will have of them actually on the car!**

Always double-check your wiring application, by orienting your view both left-to-right (compare the 3-fuse side to the 4-fuse side) **and** also top-to-bottom.

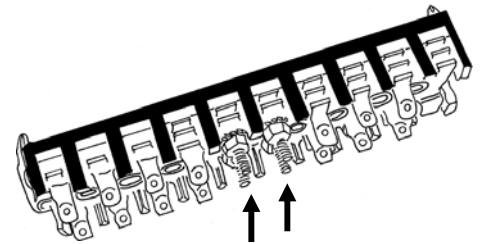
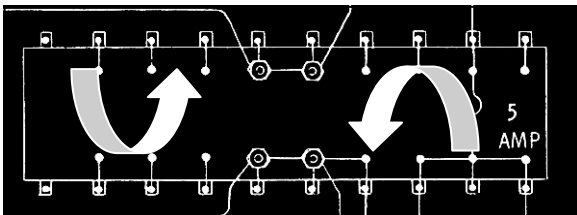

Power Connector Cleaning

Nuts at the 4 central fusebox terminals & 2 connectors at the rear of the amp gauge require maintenance.

To maximize current flow, disconnect battery, then use sandpaper to remove corrosion at these locations.

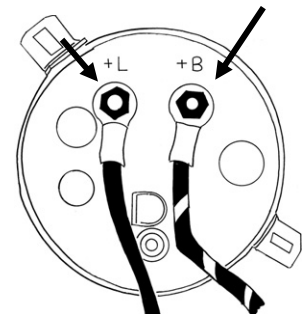

Fusebox "Terminal Reference Guide"

Disclaimers:

The following diagrams are based on a teardown of a 1971 GT. These diagrams are for reference only—the actual wiring on your car may vary, based on its model year, installed options, and whatever a mechanic or prior owner may have altered. Wire terminals may vary vertically within any particular circuit, and circuits for the rear window defogger and 1972-1973 seat belt buzzer aren't shown. We advocate confirming all wire applications using a continuity tester. OMC does not accept responsibility for your actual results.

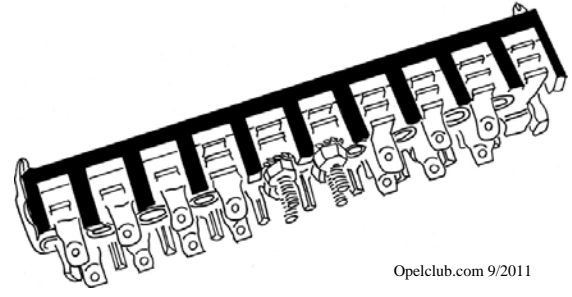

Opelclub.com 9/2011

**Always check front/rear and top/bottom orientation, by noting fuse terminal locations*

"Rear View" Fusebox Terminals*

#R/S	#7	#6	#5	#C/R	#C/L	#4	#3	#2	#1
Black/White	Gray/Green	Gray/Red	Gray/Black			Red	Black	Red/Black	Purple
Black/White	Gray/Green	Gray/Red	Gray/Black	Red/White	Red/White	Red		Red/Black	Purple
Black/White							Black/Red		Yellow/Black

Applications per Terminal

- R/S: Left Side Turn Signal Circuit
- #7: Dimmer Switch, Rear License Lenses
- #6: Right Side Parking/Marker Lights
- #5: Left Side Parking/Marker Lights
- #C/R: Amp Gauge "B+" Output (Power)

Applications per Terminal

- #C/L: Starter Solenoid (Power from Battery)
- #4: Hazard Switch, Clock, Dome Light
- #3: Cigarette Lighter (Black)
Headlight Indicator Relay (Black/Red)
- #2: Dash Gauge Common Power, Brake Light Switch
- #1: Wiper Switch, Back-Up Switch (Purple)
Horn (Yellow/Black)

Fusebox-Mounted Relays (at rear of fusebox - underside view)

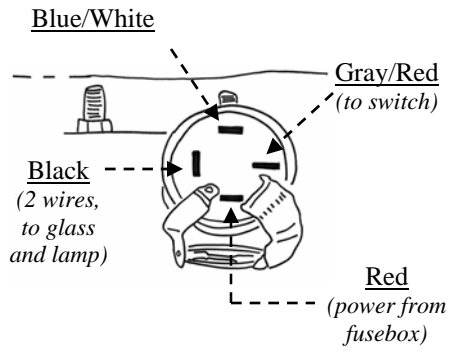

Rear Window Defroster
Rare optional circuit, not present on most Opel GT's

High-Beam Relay 5-wire relay, controls switching of high-beams on headlights

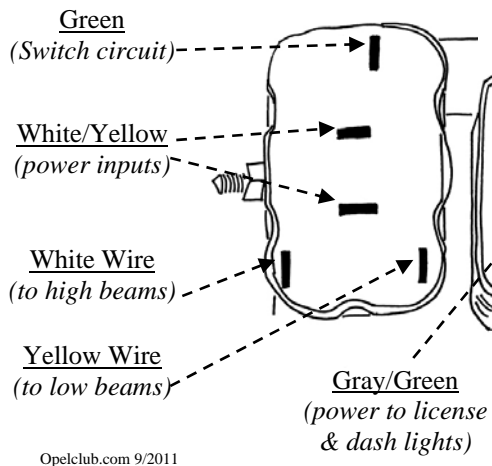

Opelclub.com 9/2011

Main Headlight Relay 7-wire relay, controls on/off switching of headlights

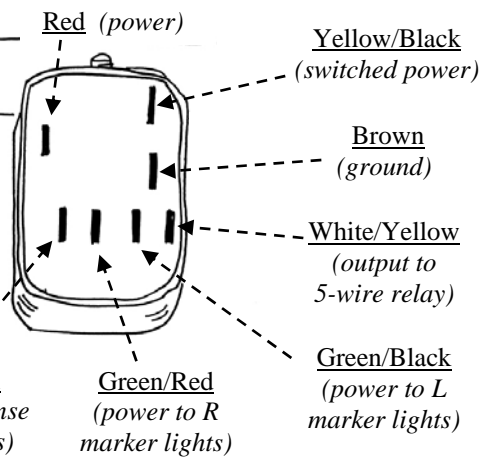

Opel GT Fuse Box Plastic Housing: Metal Support Gusset design

Over the years I have had the opportunity to repair more than my fair share of Opel GT Fuse Boxes. The first was my own 1973 GT. Luckily my GT only needed some large fender washers to keep the cracks at the black plastic box mounting stud holes from growing into a serious issue. The repair has now lasted over 11 years. I have repaired a number of GTs with this method, as I am sure many of you have.

However, the Fuse Box in your GT may have led a harder life. Perhaps a previous, less than careful, owner has neglected this simple repair. Perhaps the front mounting flange, of the fuse box, has broken off. Perhaps the Fuse Box is now hanging by its wires, and is interfering with the brake & clutch pedals. Perhaps you also do not enjoy the idea of spending a few weekends on your back replacing the entire fuse box, wire, by wire, by wire. **I have a solution for you!**

I recently repaired two GTs with this exact type of problems with a Gusset. Below I have a drawing of the Gusset which I have used to reinstall fuse boxes with missing front flanges with great success. The gusset was made from sheet metal, simple hand tools and painted with black spray paint. The repair is almost invisible and holds the fuse box very securely. *(by Dennis Gardiner, reprint from Feb 2006)*

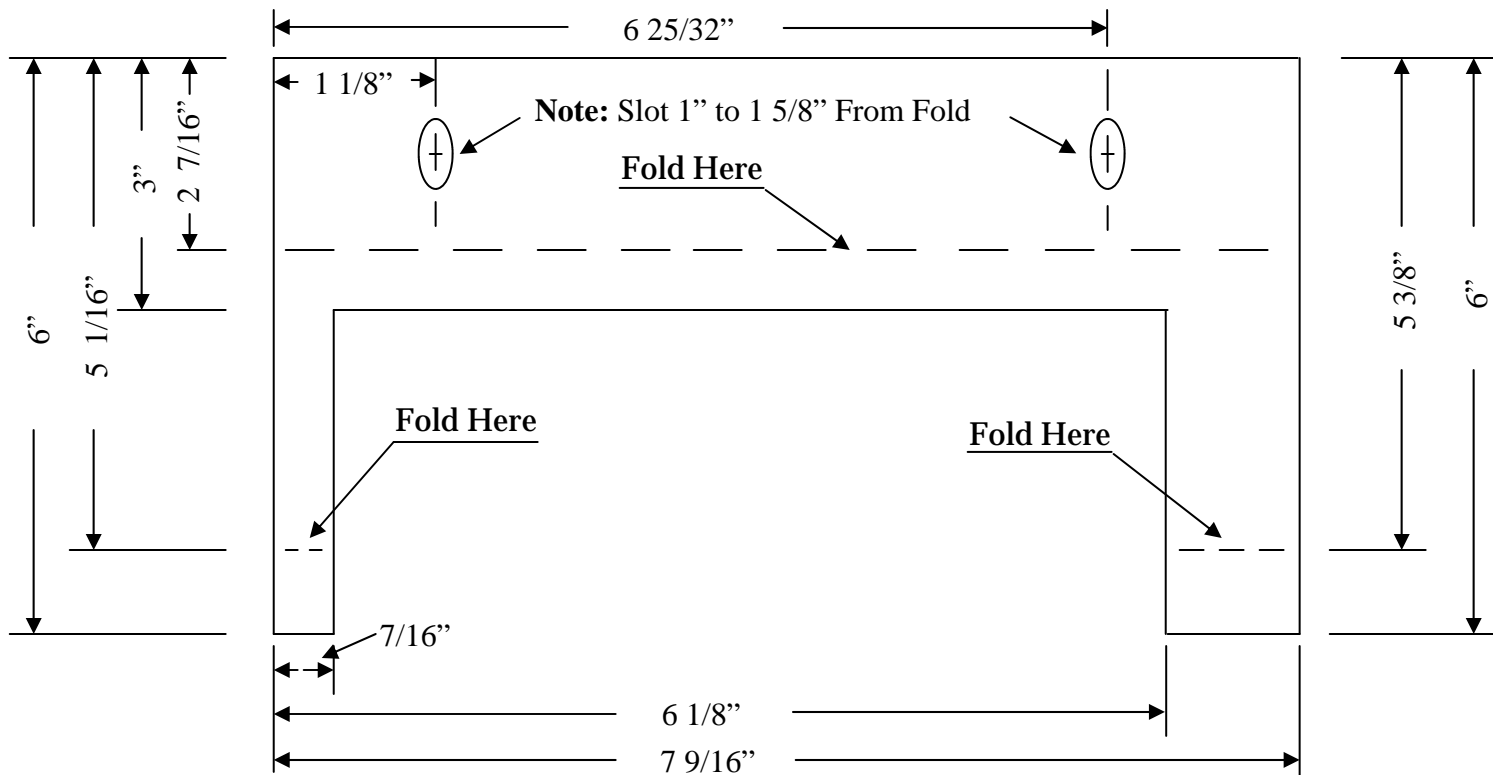

Opelclub.com 9/2011

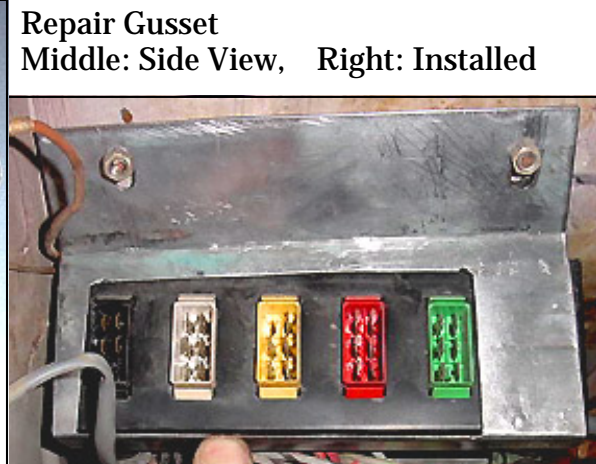
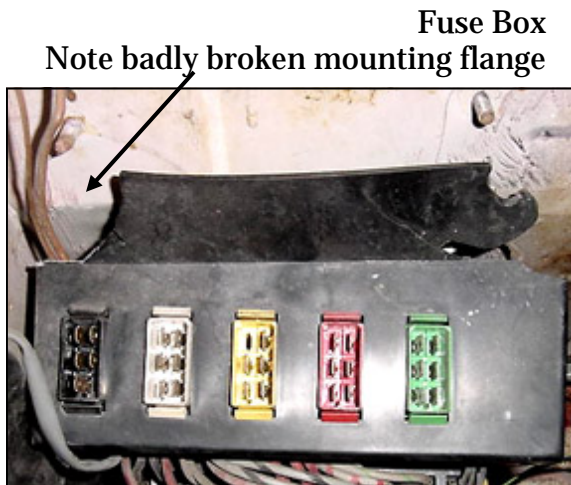

GT Underdash Harnesses

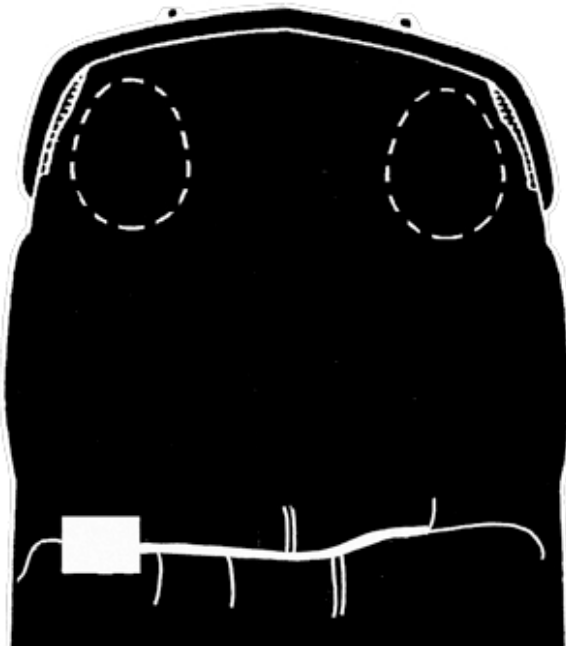

Heater Fan Connections (1970-1973 GT)

Red Wire (from fan)
Red/Black/White (striped wire from dash)
Thick Black Wire (from dash)
Black Wire (from fan)
Eyelet bolts to bracket (as ground)

Sand these wire terminals, to remove any corrosion.

Amp Gauge Wiring

Shows solid red, and striped red wires

Sand the 8mm nuts and terminals here (to remove corrosion and ensure good contacts here). This is an important connection point (for 30 amps power).

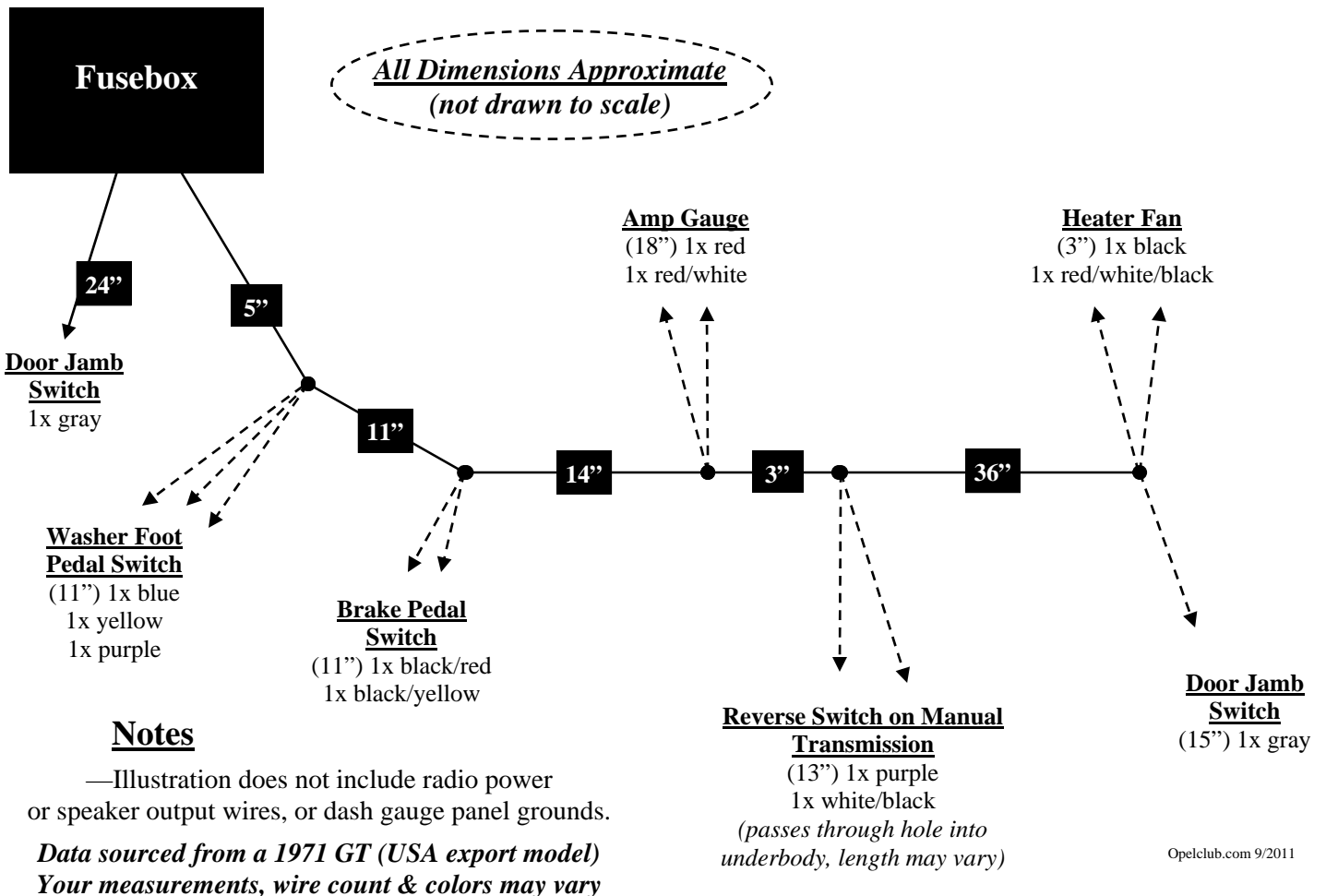

Opel GT Automatic Transmission Wiring

The Neutral Safety Switch is installed to prevent the car from being started in gear (the engine will crank only in "park" or "neutral"). This switch shares a harness which also controls the console light bulbs, the reverse light on the rear of the car, and the parking light indicator on the gauge panel. Connections are as shown below.

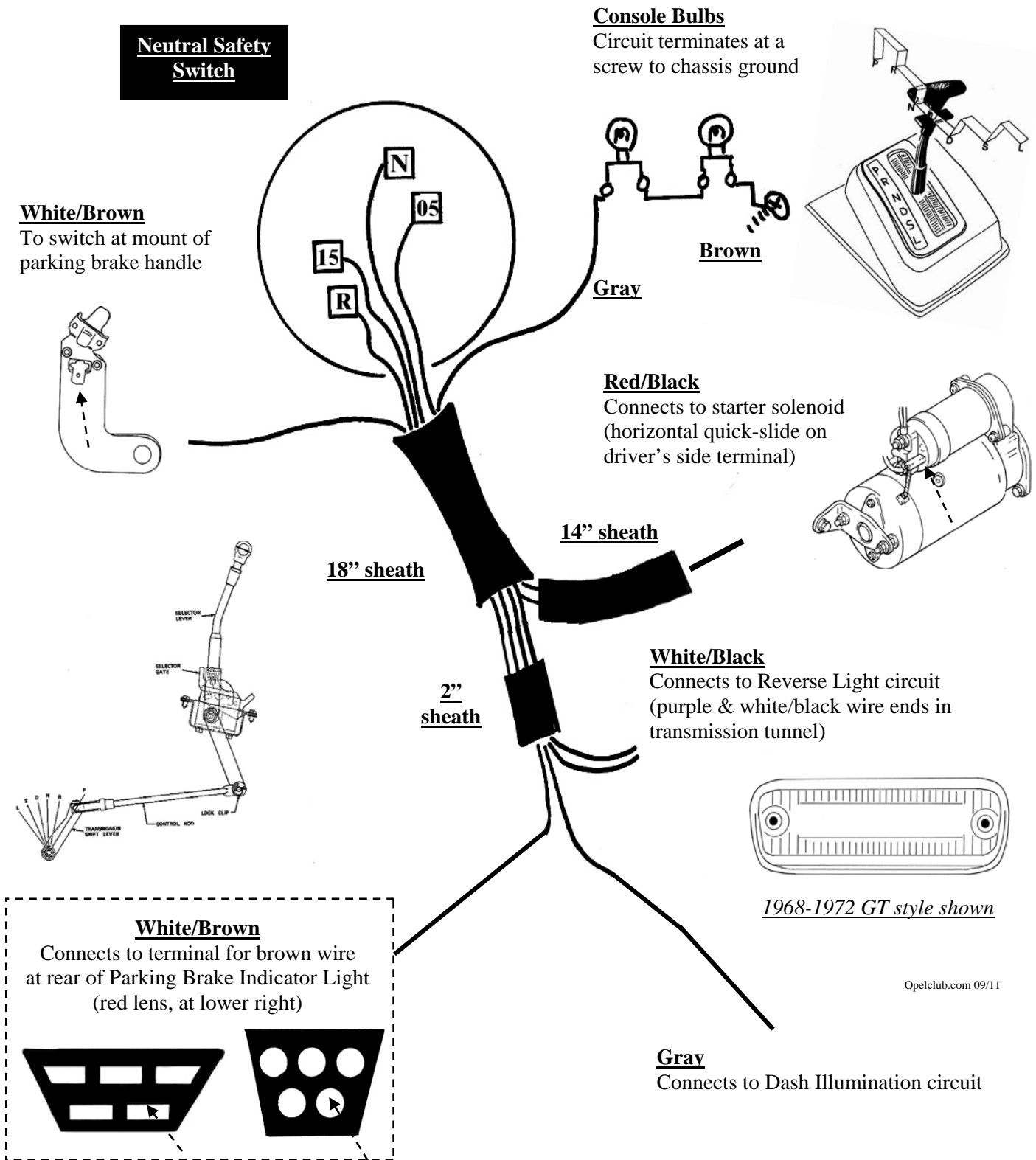

Opelclub.com 09/11

Available Schematics

Circuit schematics can be viewed in the 1973 Opel Factory Service Manual (page #1J-103, figure 1J-29).

Dash Panel Harness Plugs

Views are of ends of the plastic connectors (which plug into receptacles within the fusebox). Diagrams are oriented so that the “groove” on of each plug is at the top of each layout.

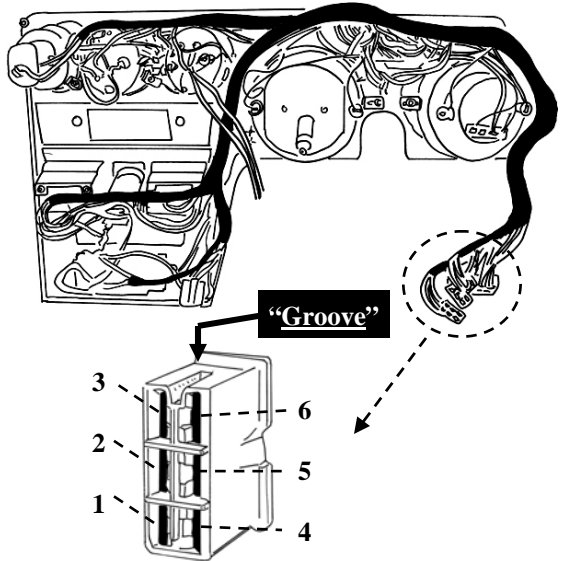

Black/White

L Turn Signal
& Hazard Switch

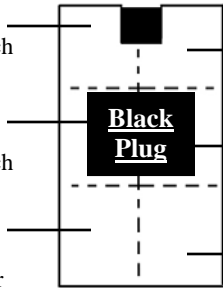

Black
Turn Signal Switch

Red (2 wires)

Clock Power
& Hazard Switch

Black Plug

Black/Green/White
Flasher & Hazard

Black/Red

Dash Panel
Common Power

Black/Green
R Turn Signal
& Hazard Switch

Green

Wiper Switch

Yellow

Wiper Switch

White

Wiper Switch

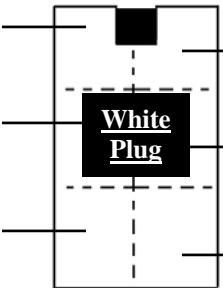

Black
Heater Fan
Switch

Blue
Wiper Switch

Purple
Wiper Switch

Gray/Green

Parking Light
Switch

Gray/Red

Parking Light
Switch

Gray/Black

Parking Light
Switch

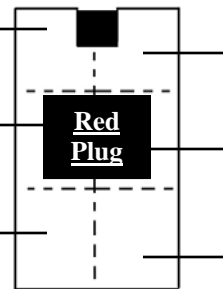

Blue
Oil Pressure
Gauge
Warning Light

Blue
Temperature
Gauge

Blue/Black
Fuel Gauge

Black/Red/White

Heater Fan Sw

Gray/Green
Dash Dimmer

Gray/Red
Rear Window
Defroster ?

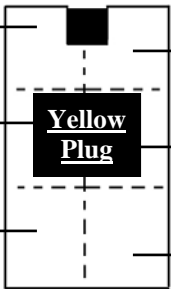

Blue/White
Amp Gauge
Warning Light

Brown
Brake Warning
Light

Red
Parking Light
Switch Power

Green

Tachometer

Brown
Speedometer
Housing Ground

Black
Cigarette
Lighter

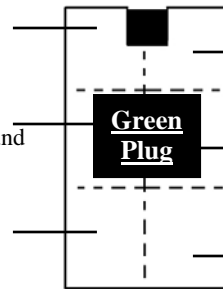

Blue/Green
Oil Pressure
Gauge

Brown/Black
Headlight
Indicator Light

White
High Beam
Indicator Light

Black/Red

Ignition Switch
“Start” position

Black

Ignition Switch
“Run” position

Brown

Horn Button

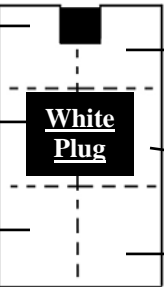

Brown/White
Door Jamb
Switches?

(Blank)

Red
Turn Signal
Switch Power

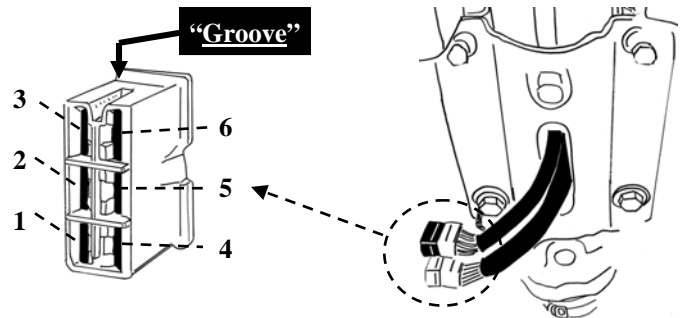

Steering Column Harness Plugs

Views are of plastic connectors, which plug into side of fusebox. Note there are some year-to-year variations (high beam wire may be brown/white or green) and a seat belt buzzer circuit (a gray wire, added in 1971).

Gray/Black

Turn Signal Switch

Gray/Red

Turn Signal Switch

Green

High-Beam Switch

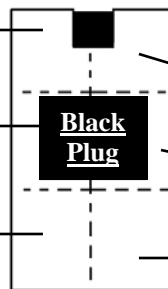

Black/Green

Turn Signal Switch—Right

Black/Green/White

Turn Signal Switch (Common)

Black/White

Turn Signal Switch—Left

Opel GT Dash Panel Wiring Guide

This simplified version is for someone who has removed the panel (hopefully using our instructions from the March/April 2009 OMC Blitz) and wants to reattach a loose wire or swap over a gauge or switch (without deciphering confusing configurations found on other schematics).

Be aware there some year-to-year variations (mostly on the 1969 panel compared to the 1970-1973 years) and application variations (stereo, defroster, and the parking brake warning indicator and/or neutral-safety switch when installed).

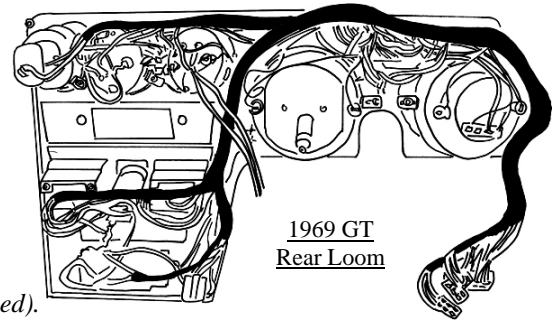

Wire gauge sizes are shown (in parentheses): (Higher numbers are thinner)
Brown wires are grounds.
Gray wires illuminate bulbs.

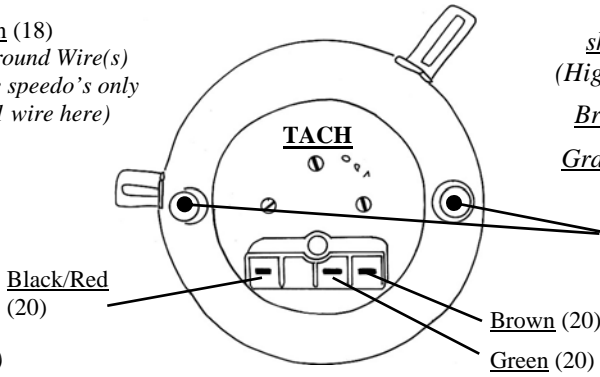
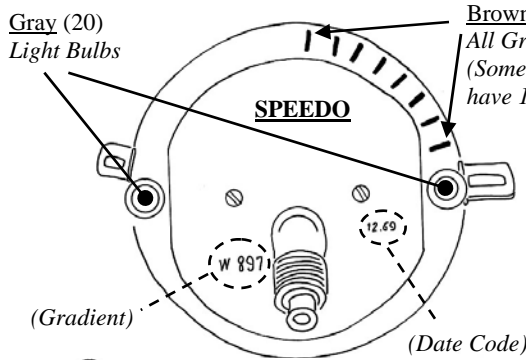

Opelclub.com 9/11

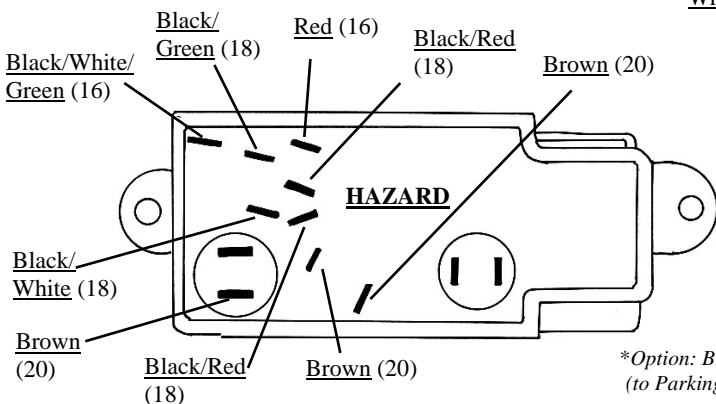
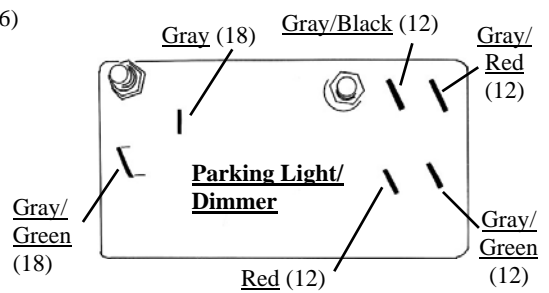
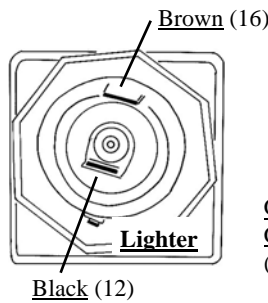
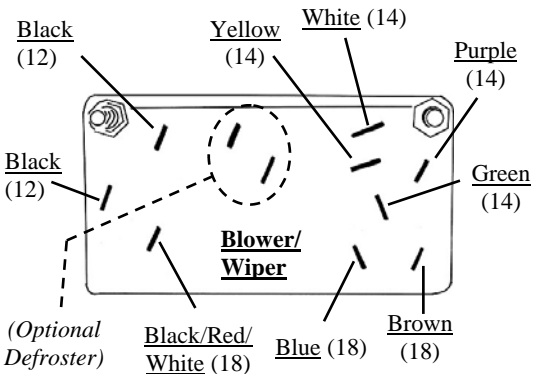
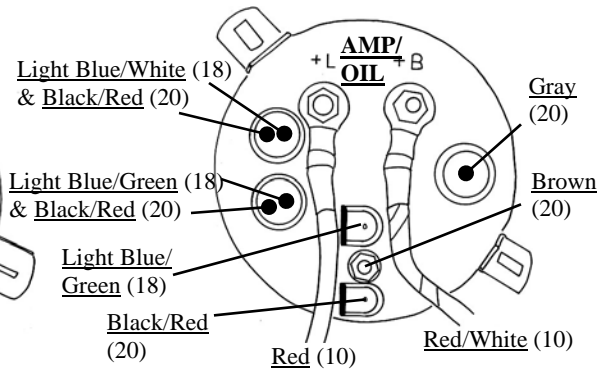
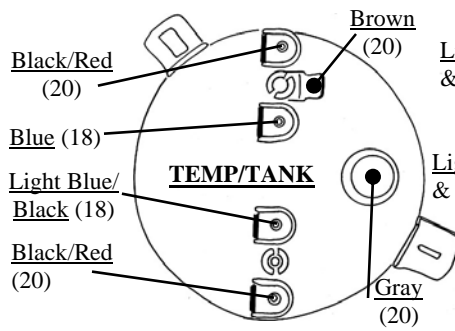
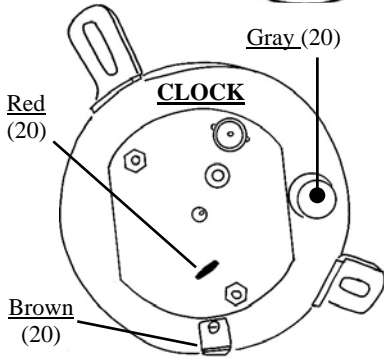

*Option: Brown/White (20) (to Parking Brake Switch)
**Per original factory guide

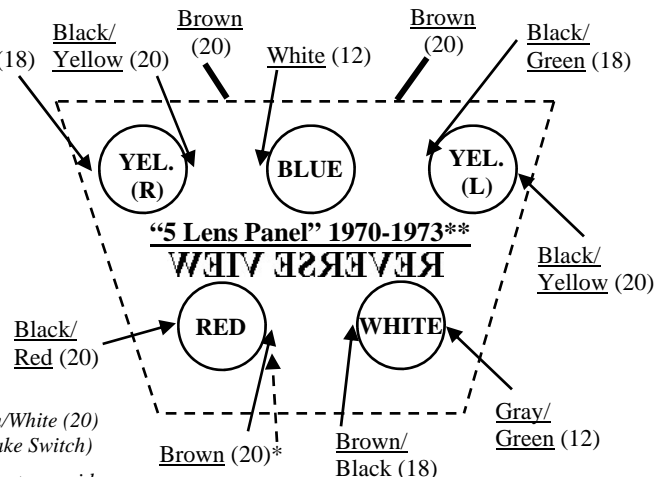

GT Underhood Harnesses

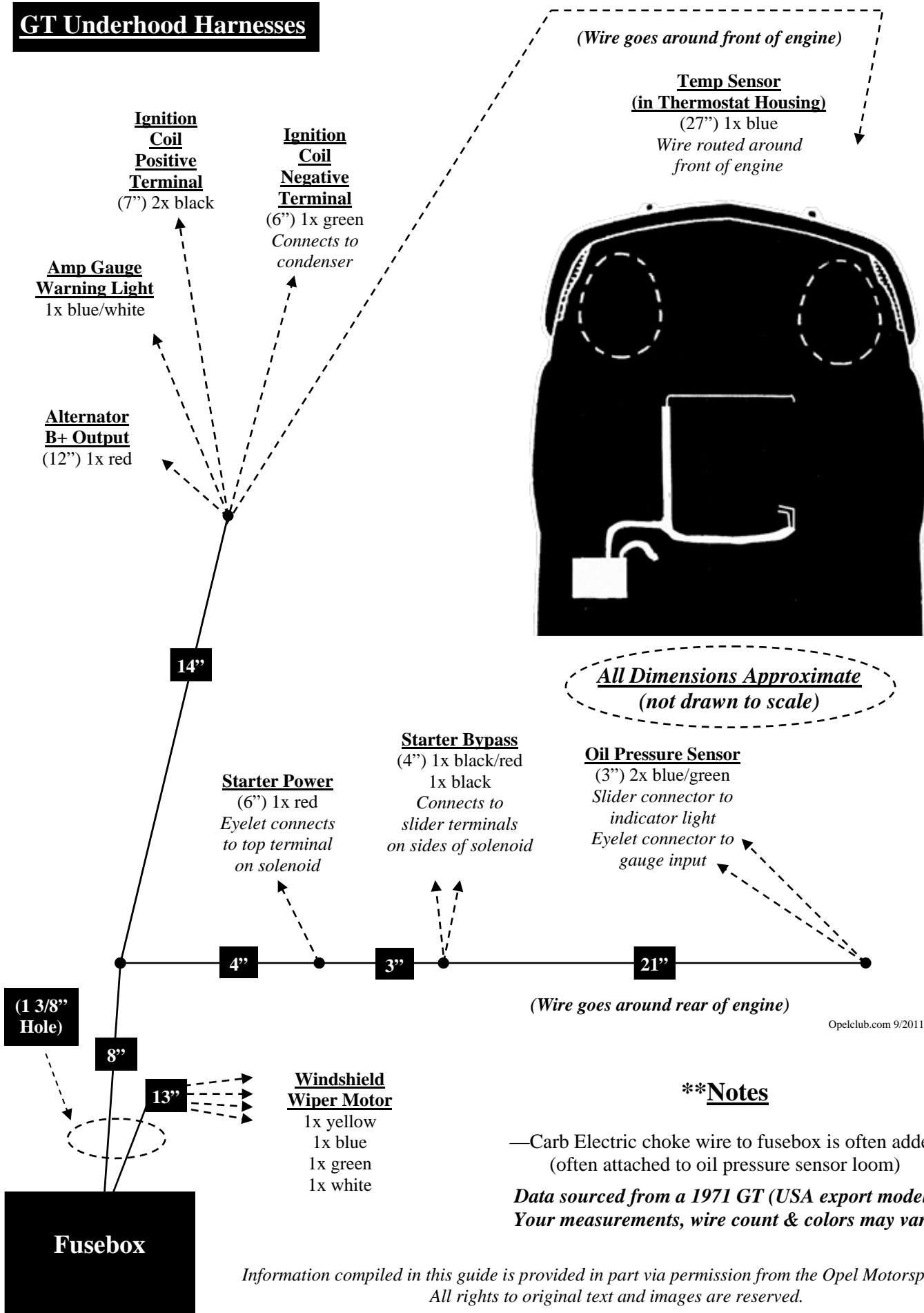

Opelclub.com 9/2011

**Notes

—Carb Electric choke wire to fusebox is often added (often attached to oil pressure sensor loom)

*Data sourced from a 1971 GT (USA export model)
Your measurements, wire count & colors may vary*

*Information compiled in this guide is provided in part via permission from the Opel Motorsport Club.
All rights to original text and images are reserved.*

GT Front Light & Horn Harness

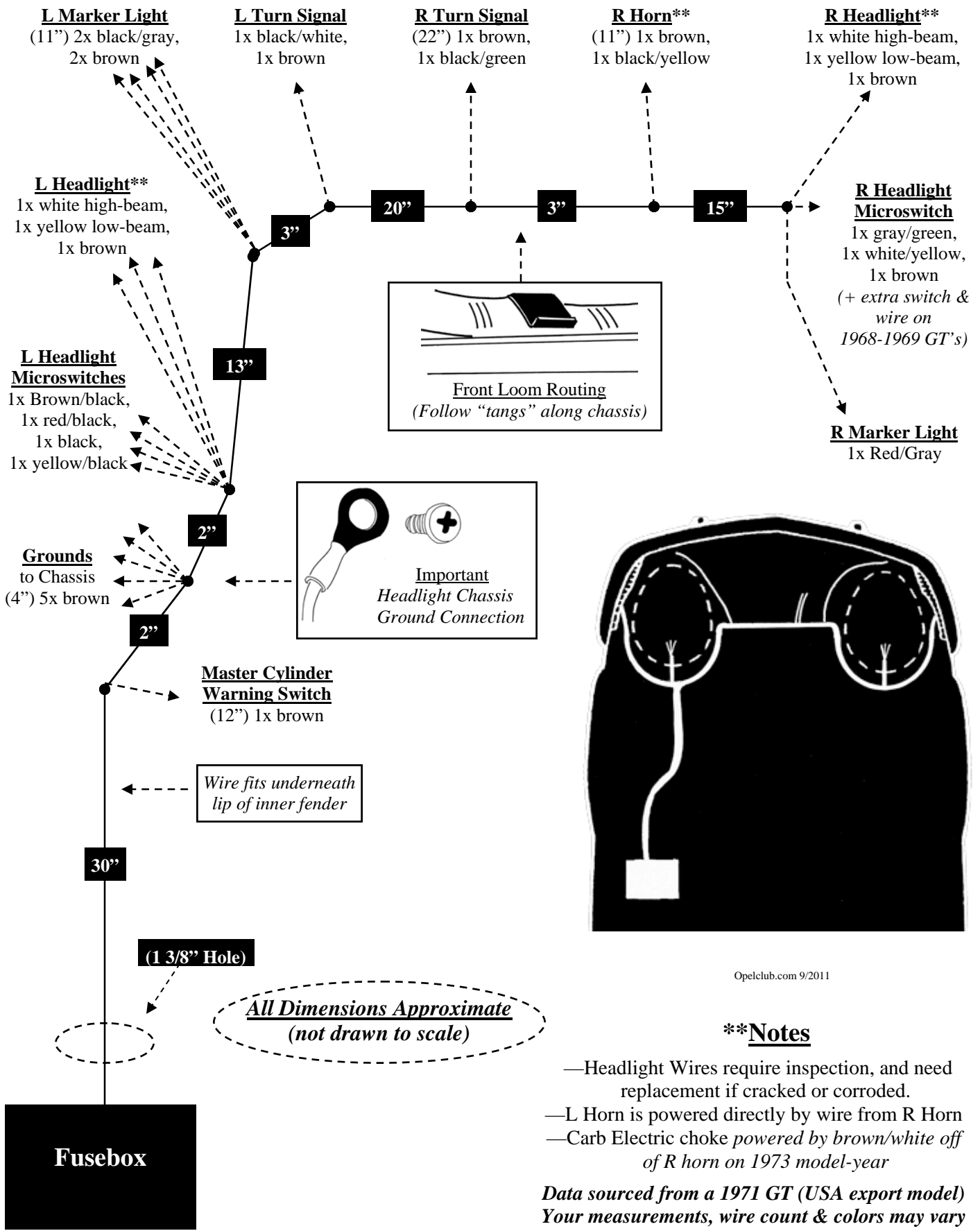

Opelclub.com 9/2011

**Notes

- Headlight Wires require inspection, and need replacement if cracked or corroded.
- L Horn is powered directly by wire from R Horn
- Carb Electric choke powered by brown/white off of R horn on 1973 model-year

*Data sourced from a 1971 GT (USA export model)
Your measurements, wire count & colors may vary*

GT Rear Body Harness

Fusebox

*All Dimensions Approximate
(not drawn to scale)*

Notes

Illustration does not include radio speaker output wires or seat belt indicator wires.

*Data sourced from a 1971 GT
(USA export model)*

*Your measurements, wire count
& colors may vary
(Taillight design was changed on 1973 GT's,
after chassis #0YONC-310096)*

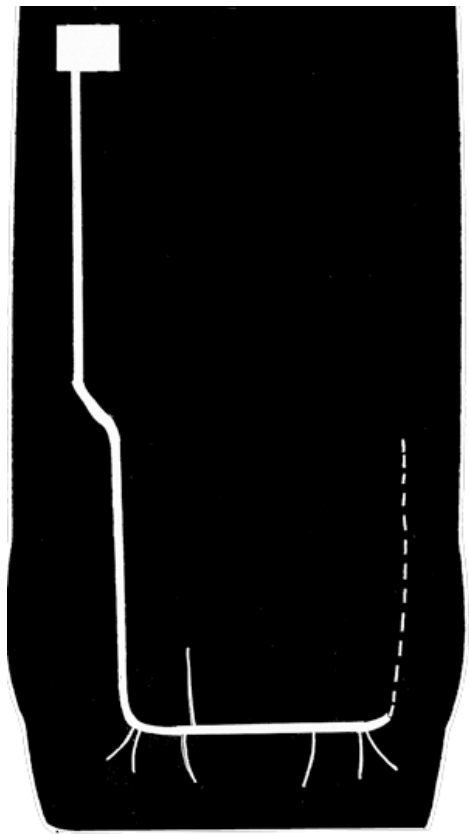

120"

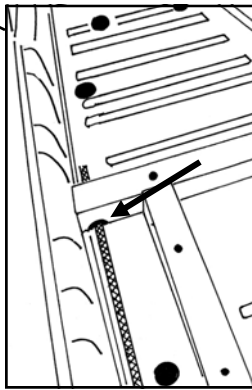

*Wire loom routes through
holes in seat rails, on
driver's side floor of body*

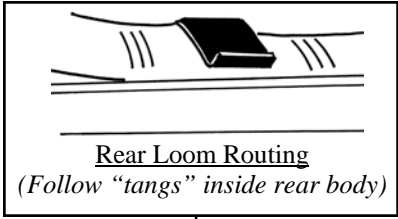

*Rear Loom Routing
(Follow "tangs" inside rear body)*

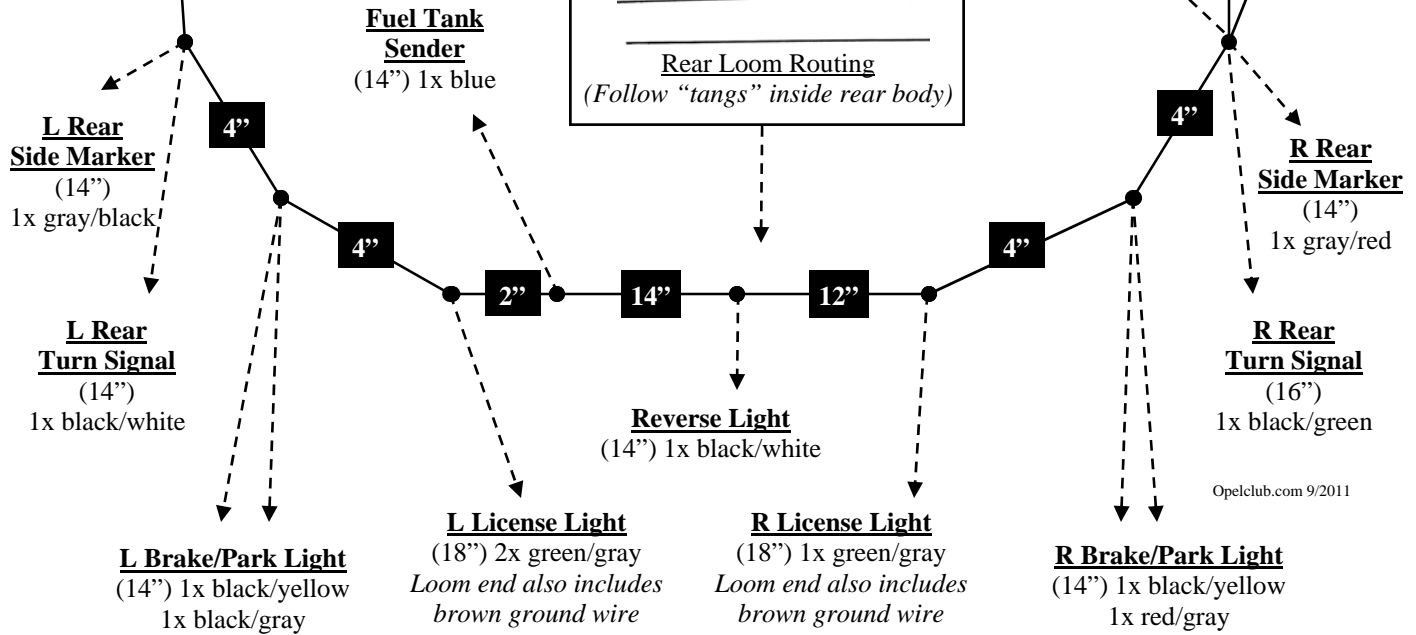

Dome Light
(58") 1x red & 1x gray
Connects via 2 plastic plugs

Opel GT Circuit Schematics *

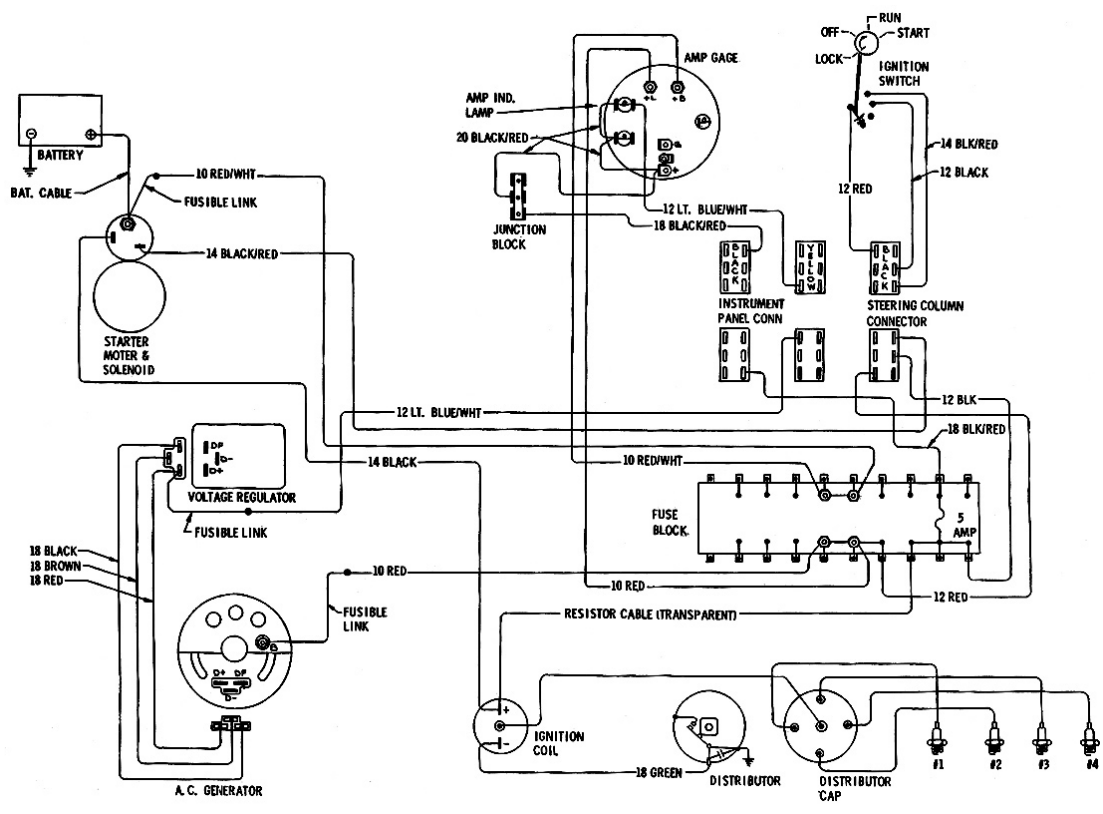

Starting, Ignition & Charging circuits * Opel GT (1.9L Engine, USA 1969-1973)

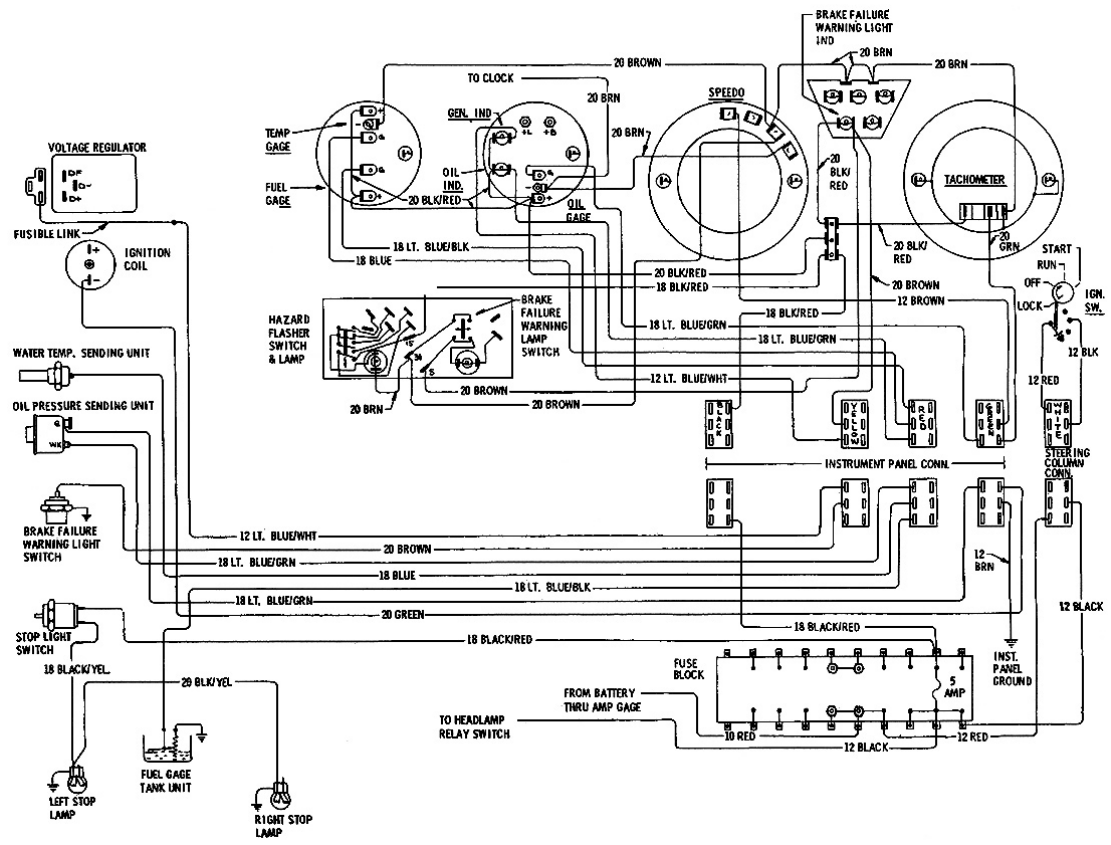

Oil, Fuel, Temp, Tachometer, Stop & Brake Warning Light circuits
* Opel GT (1.9L Engine, USA 1969-1973)

Opel GT Circuit Schematics *

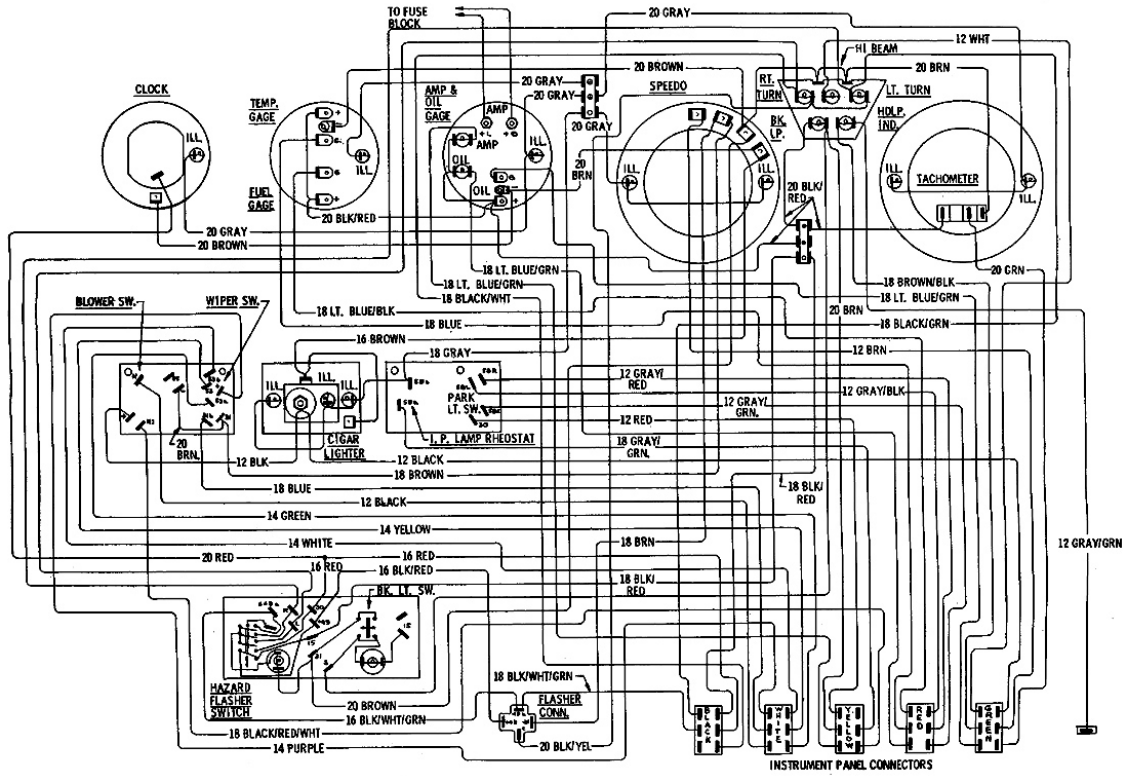

Instrument Panel Light circuits * Opel GT (1.9L Engine, USA 1969-1973)

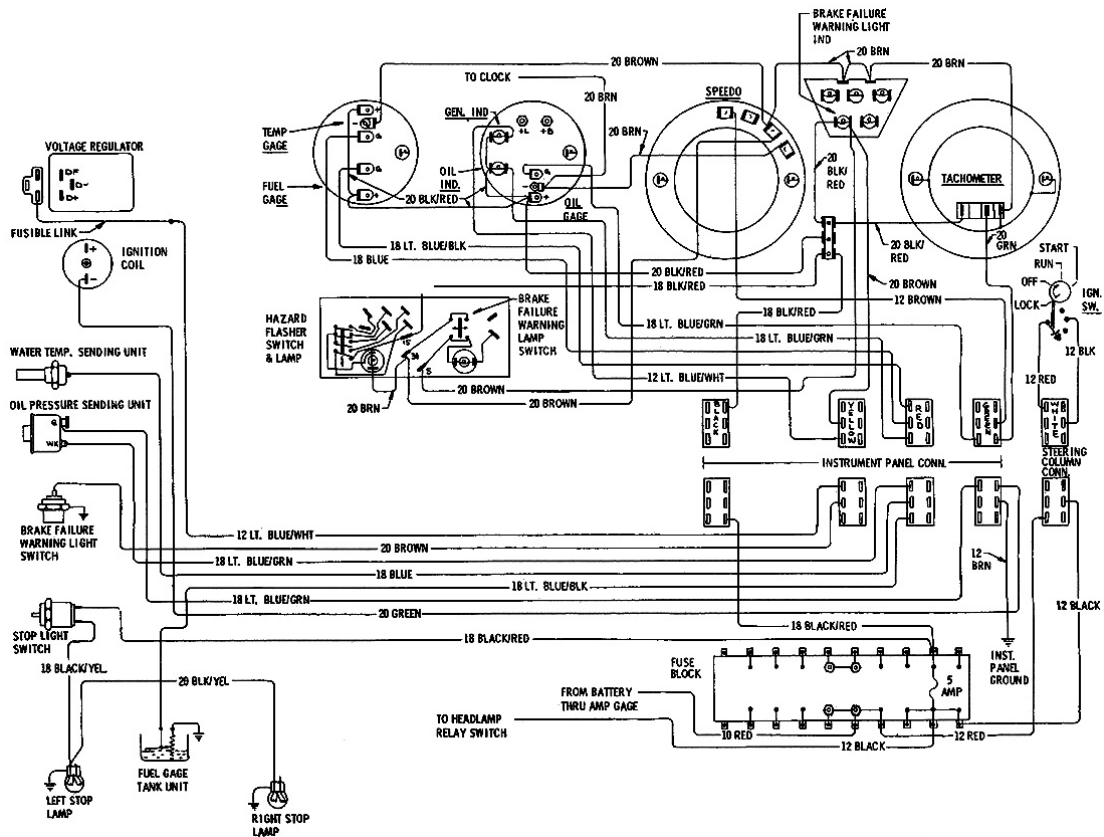

Headlamp, Parking, Tail & Instrument Illumination circuits

* Opel GT (1.9L Engine, USA 1969-1972. Note: Taillights changed after Jan 1, 1973)

Opel GT Circuit Schematics * *

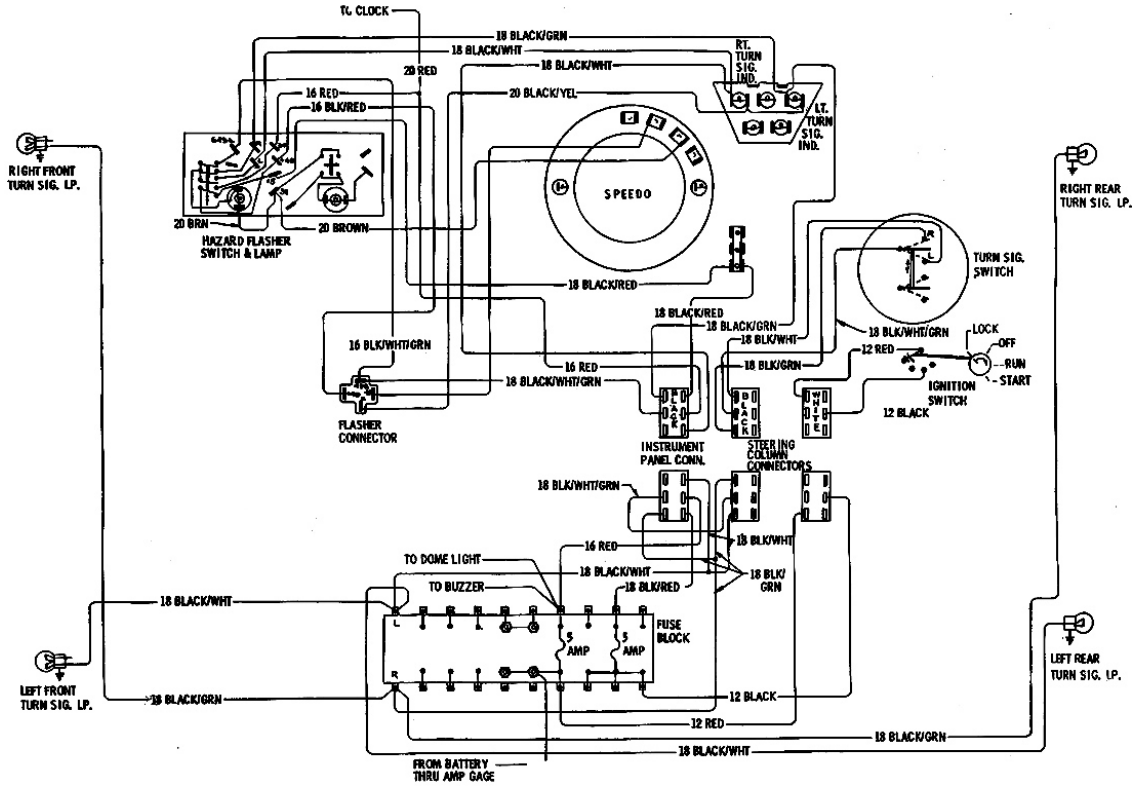

Turn Signal & Hazard Flasher circuits * Opel GT (1.9L Engine, USA 1969-1973)

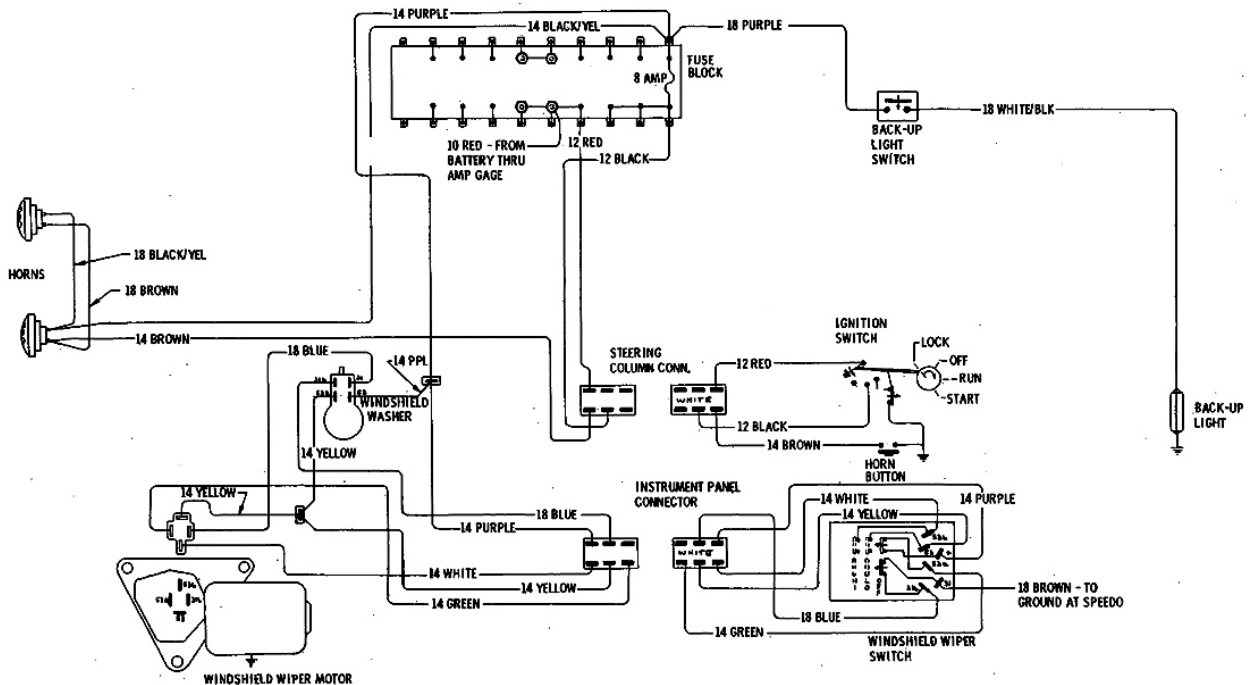

Wiper, Washer & Horn circuits * Opel GT (1.9L Engine, USA 1969-1973)

Opel GT Circuit Schematics *

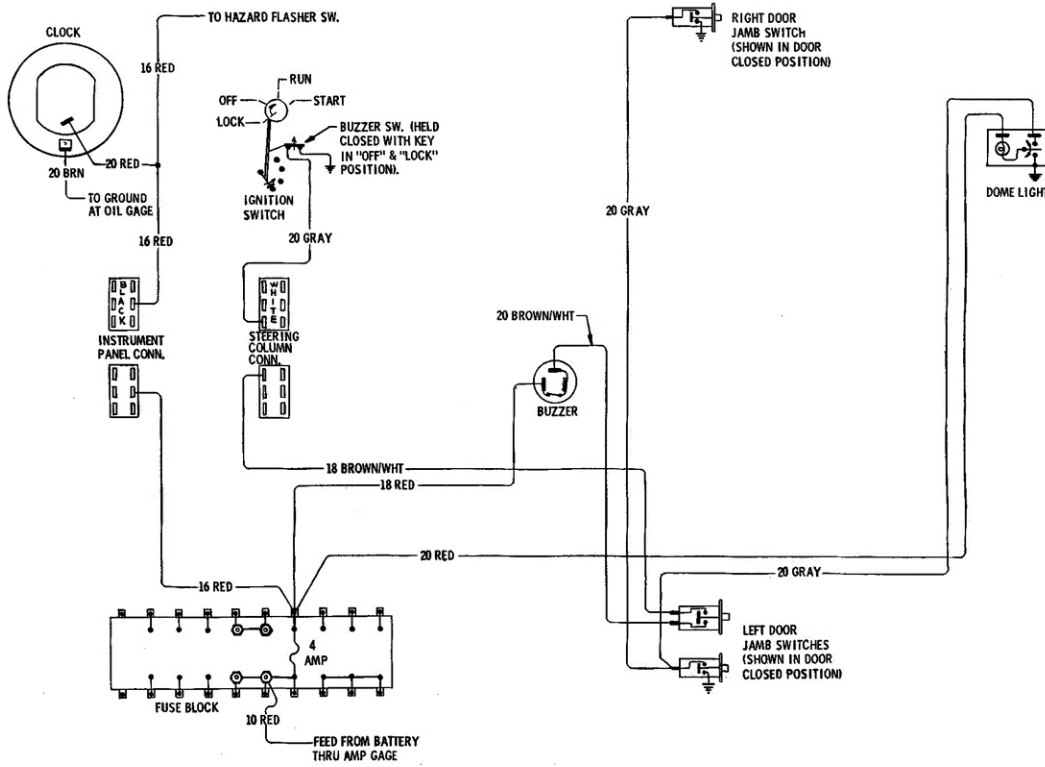

Clock, Dome Light & Buzzer circuits * Opel GT (1.9L Engine, USA 1972-1973)

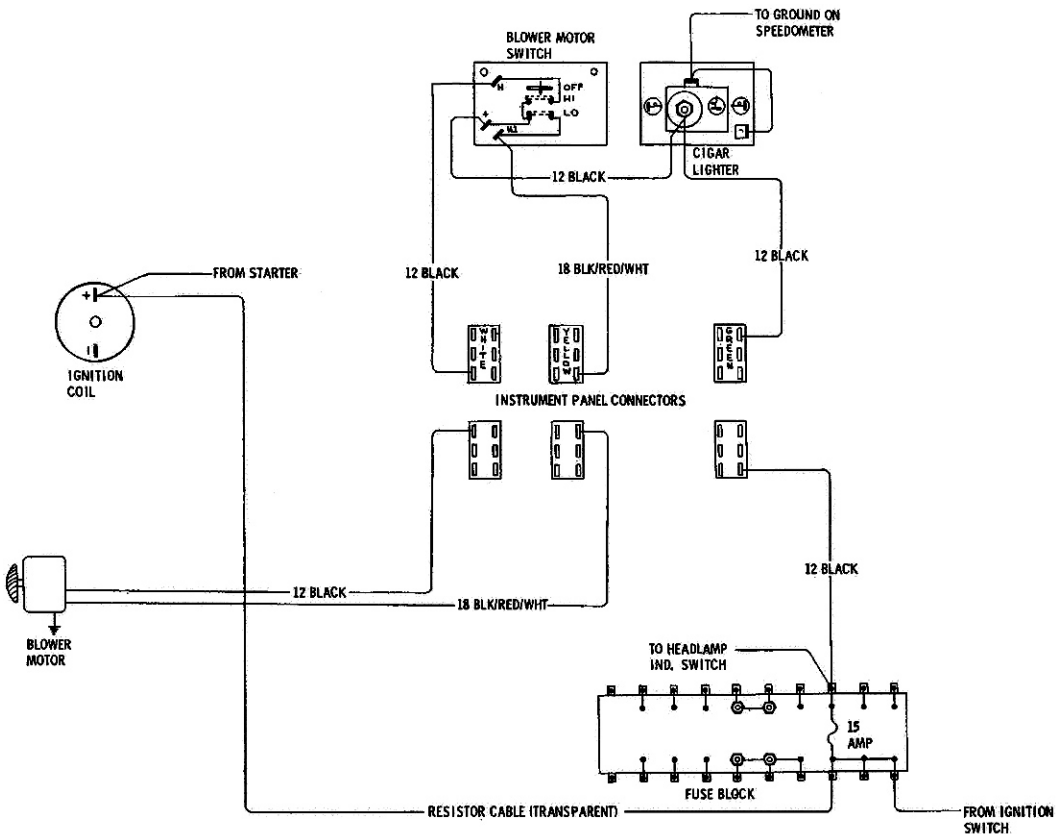

Blower Motor & Lighter circuits * Opel GT (1.9L Engine, USA 1969-1973)